

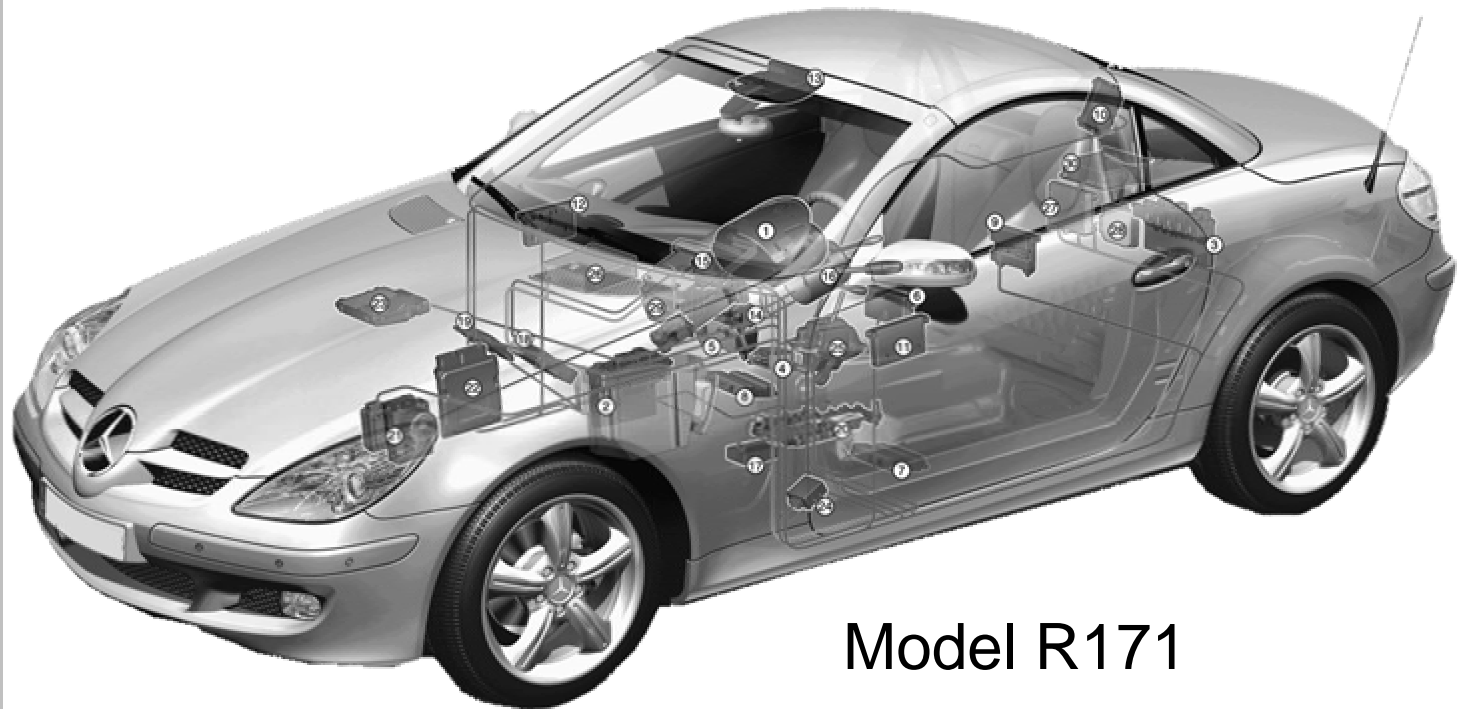

Mercedes-Benz

Audio & Communications



Model R171

Objectives

At the end of this session, you will be able to:

1. Properly connect the microphones to Tele Aid and Cell Phone
2. Configure MOST for vehicles with Audio 20 or COMAND equipment
3. Explain the basic operation of Navigation, Audio Gateway, CD changer and Satellite radio
4. Describe components necessary for Cell Phone installation
5. Locate Antennas and describe the flow paths for their signals

These technical training materials are current as of the date noted on the materials, and may be revised or updated without notice.
Always check for revised or updated information.

To help avoid personal injury to you or others, and to avoid damage to the vehicle on which you are working, you must always refer to the latest Mercedes-Benz Technical Publication and follow all pertinent instructions when testing, diagnosing or making repair.

Illustrations and descriptions in this training reference are based on preliminary information and may or may not correspond to the final US version vehicles. Refer to the official introduction manual and WIS when available.

Copyright Mercedes-Benz USA, LLC, 2004

Reproduction by any means or by any information storage and retrieval system or translation in whole or part is not permitted without written authorization from Mercedes-Benz USA, LLC or its successors.

Published by Mercedes-Benz USA, LLC

Printed in U. S.A.

Contents

Tele Aid	4
Head Units	10
Audio 20 / MOST	11
COMAND / MOST	13
DVD-based Navigation	16
Audio Gateway	17
CD Changer	20
Satellite Radio	21
Cell Phone	22
Antennas	28
Appendix	37

Digital Tele Aid

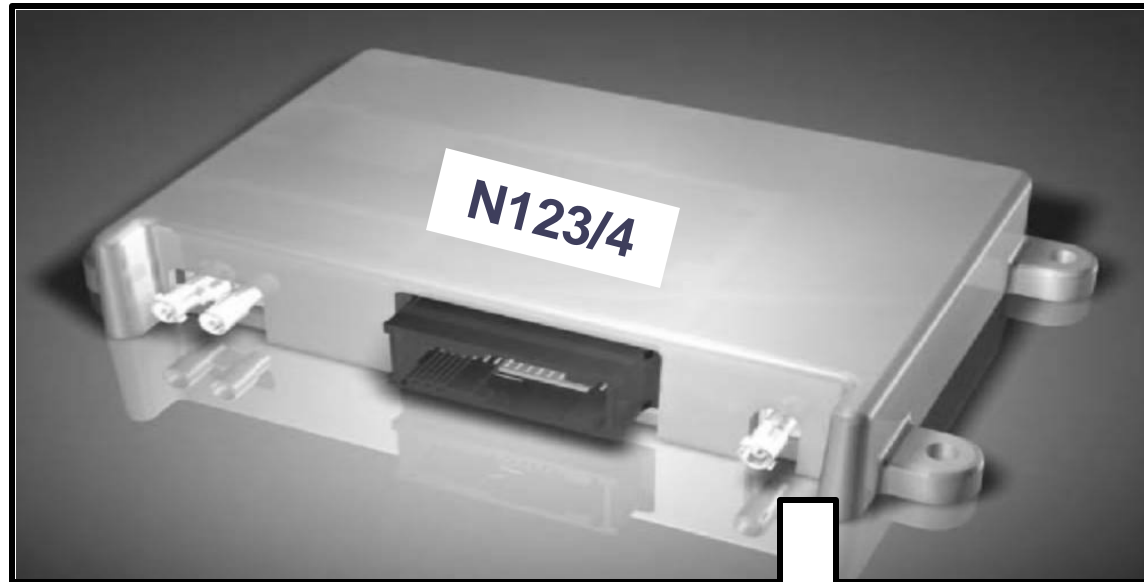

Located on Module Bridge in trunk – Right side

(Basic Tele Aid info can be found in other training courses)

Tele Aid Microphone (B25b1)

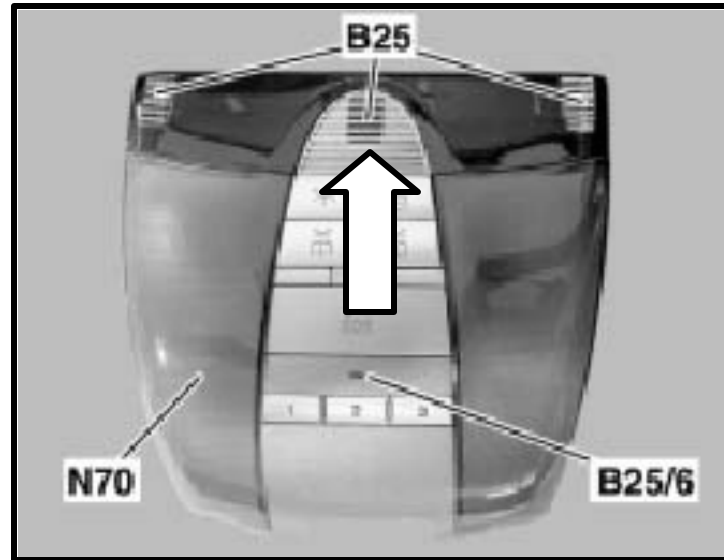

Overhead Control Panel (N70)

B25b1 Connected to Tele Aid directly
(Unless cell phone installed. See p.26)

*B25/6: Dynamic Range Optimization (DRO) microphone for Audio Gateway
(COMAND system only)*

Tele Aid Microphone Connection

Hook-up in trunk: without cell phone

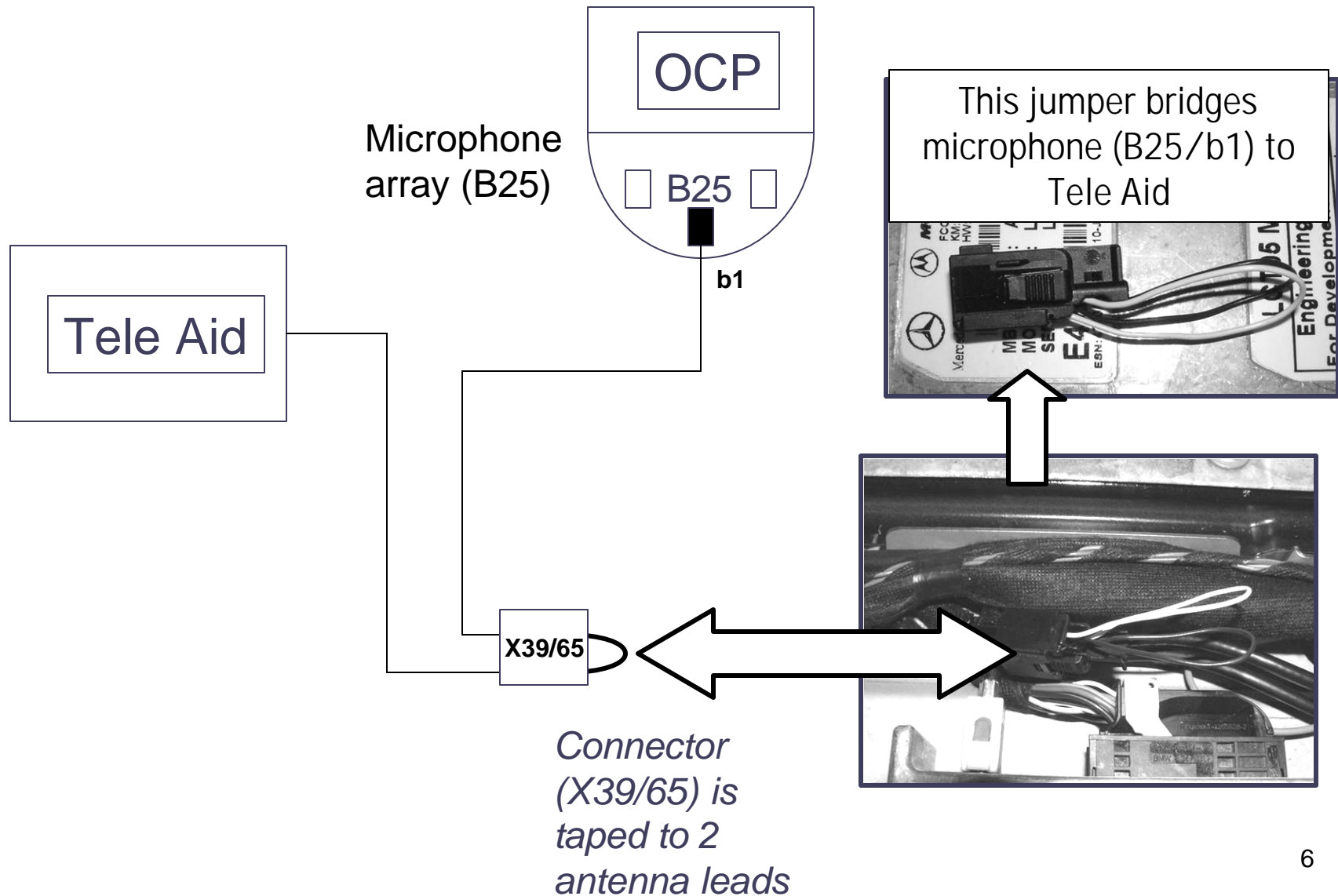

Tele Aid Speakers

- Left and right A-pillar speakers wired in parallel from Tele Aid unit
- Volume is not adjustable

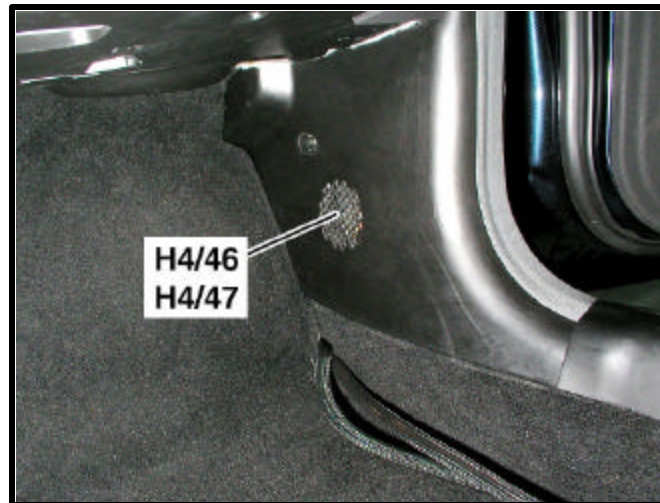

Location:

H4/46: Left front emergency call speaker
H4/47: Right front emergency call speaker

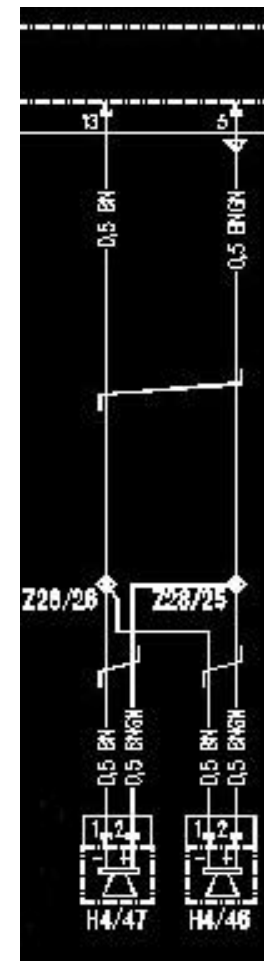

Tele Aid Antennas

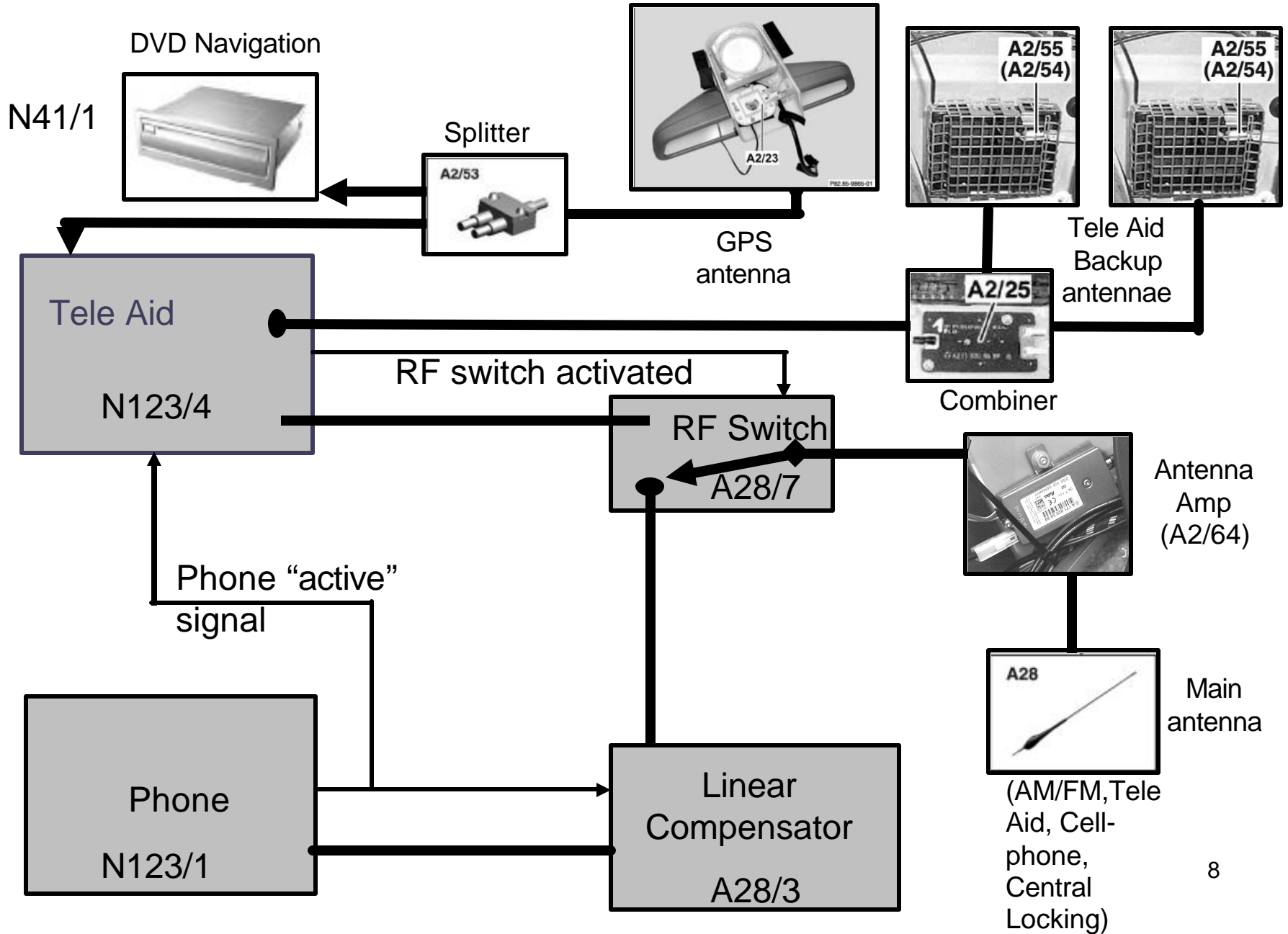

Review #1

1. How many microphones are used for Tele Aid?
2. How many antennas are used by Digital Tele Aid?

Two Head Units Possible



Audio 20	COMAND
Designation: A2	Designation: A40/3
Standard equipment	w/Entertainment package option
Head Unit/amp/tuner in one piece	Head unit separate from Audio Gateway
CD slot <i>below</i> screen	CD & MP3 disc slot <i>above</i> screen
Not MP3-capable	MP3-capable
Navigation not available	DVD-based Navigation optional

Audio 20 (A2)



- The Head Unit and Audio Gateway/sound amplifier in one component, and are hard-wired to the 9 speakers
- Vehicle speed –related volume adjustment
- Single-disc CD player (Not for MP3 discs)
- When no additional components are installed, there is no need for a connection to the MOST ring
- If optional components (phone or CDC) are retrofitted, then the MOST ring must be connected and configured!
- When connected to the MOST ring, Audio 20 is the gateway

Audio 20 – MOST Configuration

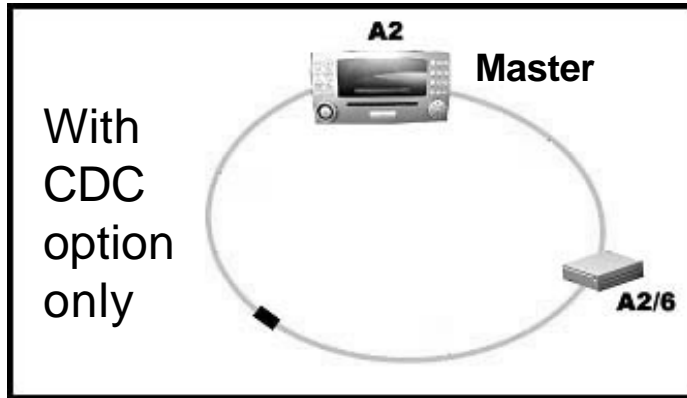

Optical cables connected under passenger seat – none used in trunk. Shown with optional CDC installed.

- A2 - Audio 20 HU (Master)
- A2/6 - CD Changer
- N123/1 - Multiple Handset Interface (MHI)

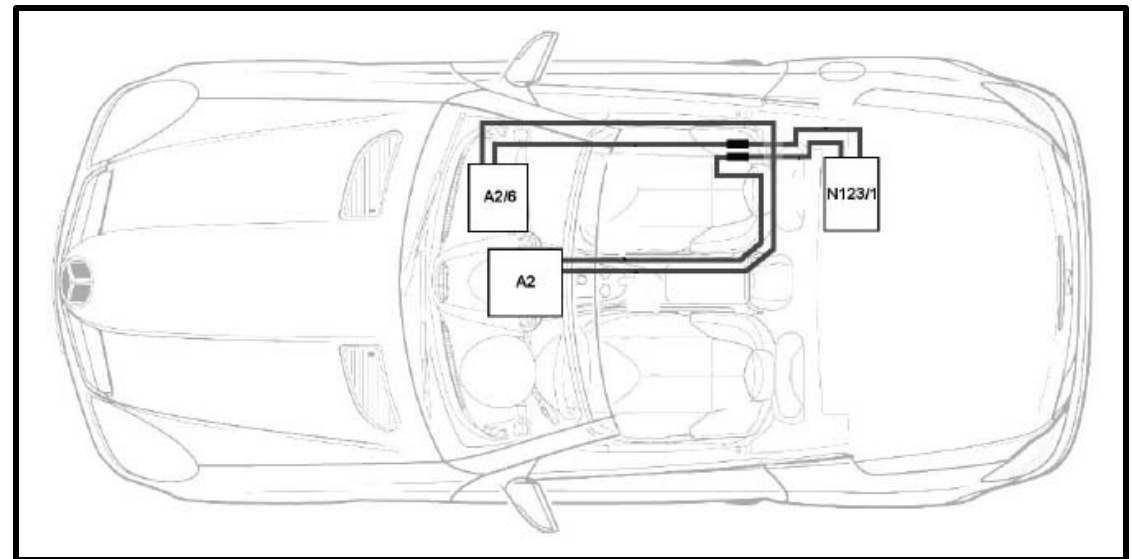

① Optional Satellite Radio (N87/5) position

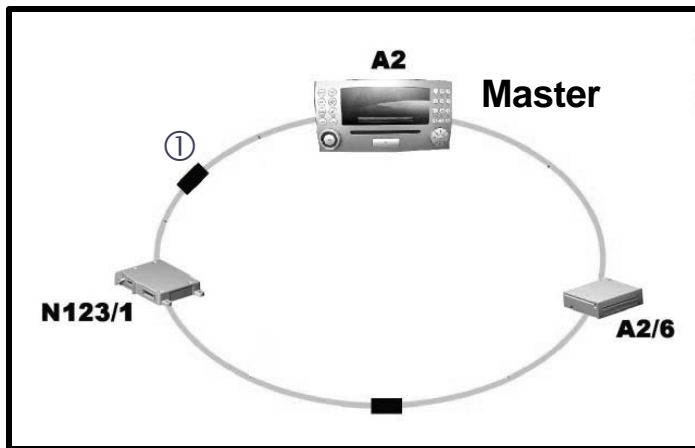

Configuration if CD Changer and phone (MHI) are added.

COMAND (A40/3)



- The COMAND head unit is installed as part of the Entertainment Package option
- Audio CD and MP3-capable (Not DVD-capable!)
- Aux input socket – right side of glove box
- Audio slot may be used for downloading Head Unit update software

COMAND Details



Display when MP3 disc is inserted in COMAND slot

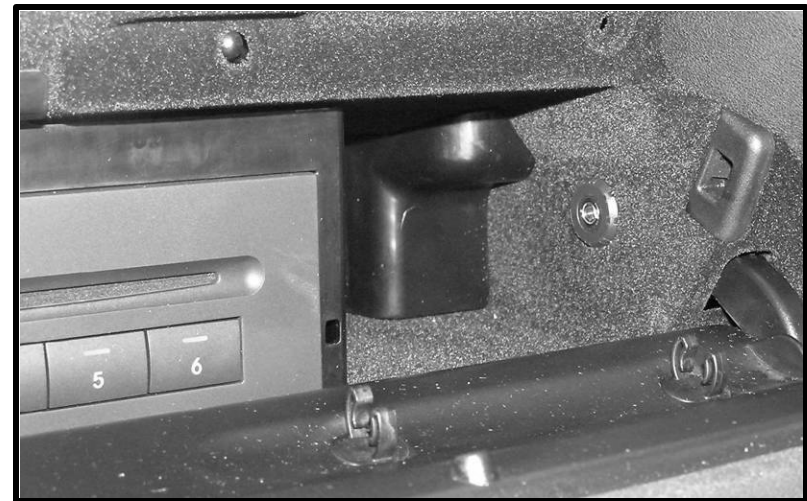

Auxiliary input jack

COMAND – MOST Configuration

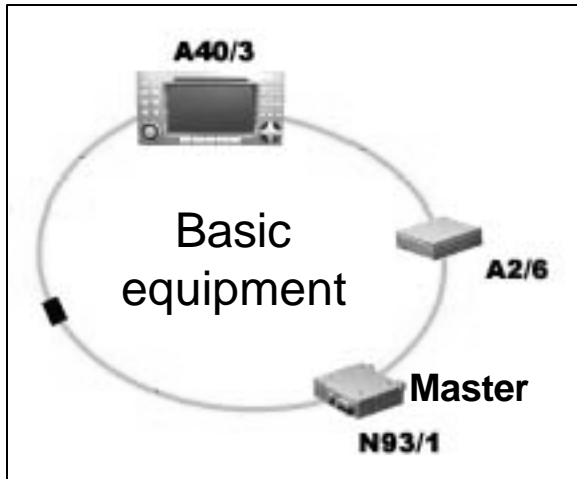

Optical cables connected under passenger seat – none used in trunk

- A2/6 - CD Changer
- A40/3 - COMAND HU
- N41/1 - NAV processor
- N93/1 - Audio gateway (Master)
- N123/1 - Multiple Handset Interface (MHI)

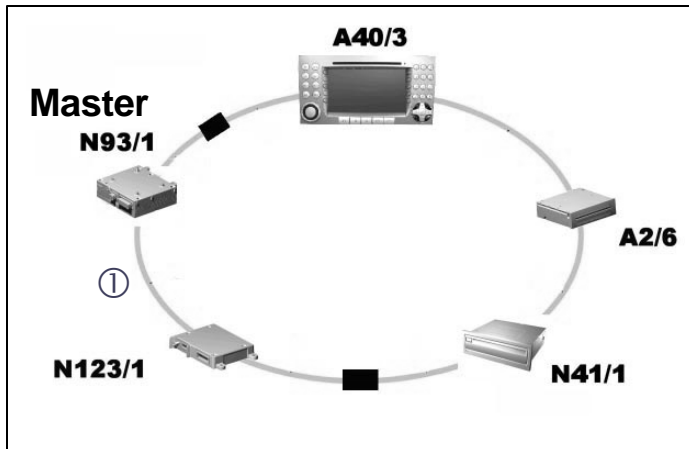

Configuration if NAV processor & phone (MHI) are added.

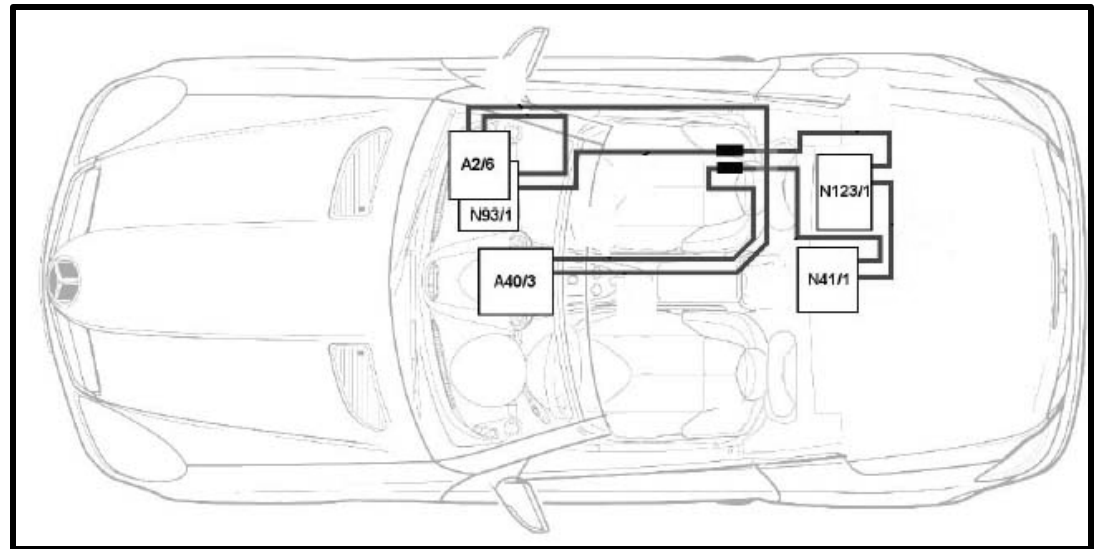

① Optional Satellite Radio (N87/5) position

DVD-Based Navigation Unit (N41/1)

- Similar to V220
- Includes:
 - GPS receiver
 - Central processor
 - DVD drive circuitry
 - Integrated gyro sensor
 - MOST interface

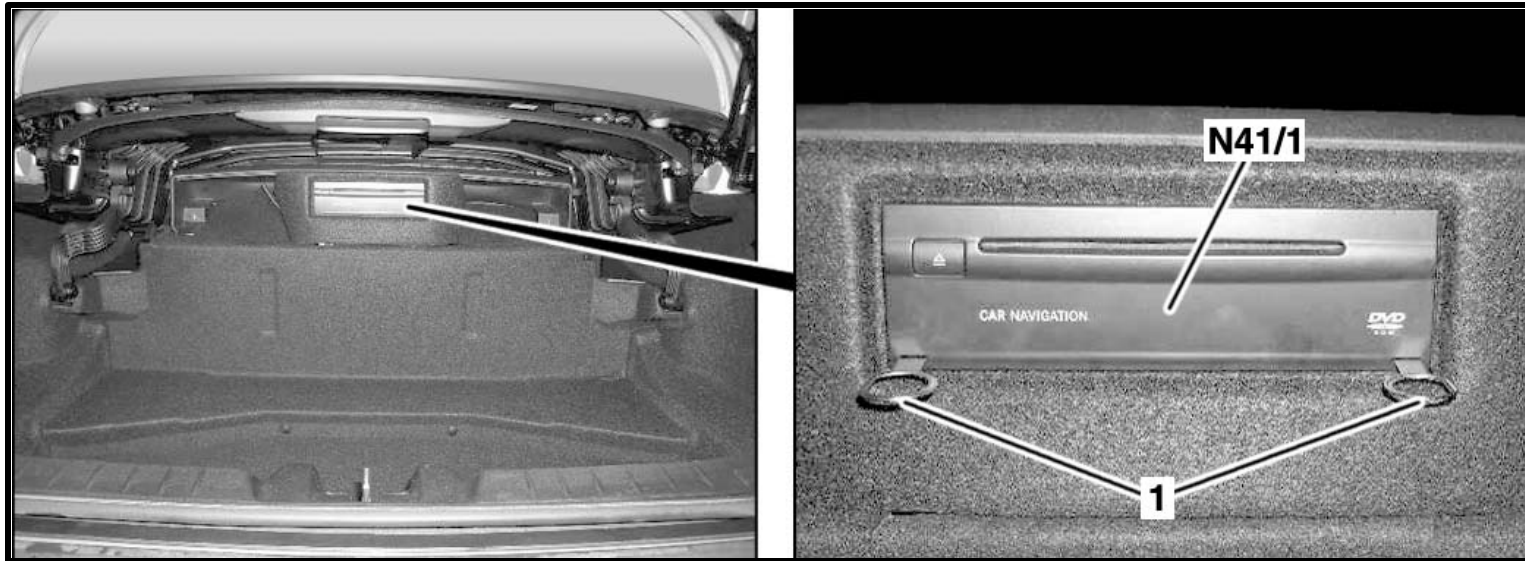

Trunk

1= Removal keys

Audio Gateway (N93/1)

- ① MOST connection plug
- ② Connection plug IF connection
- ③ antenna connection plug
- ④ Loudspeaker outputs connection plug
- ⑤ Antenna power supply/+ connection plug
- ⑥ DRO microphone connection plug

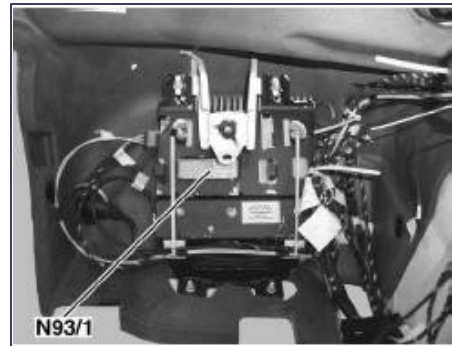
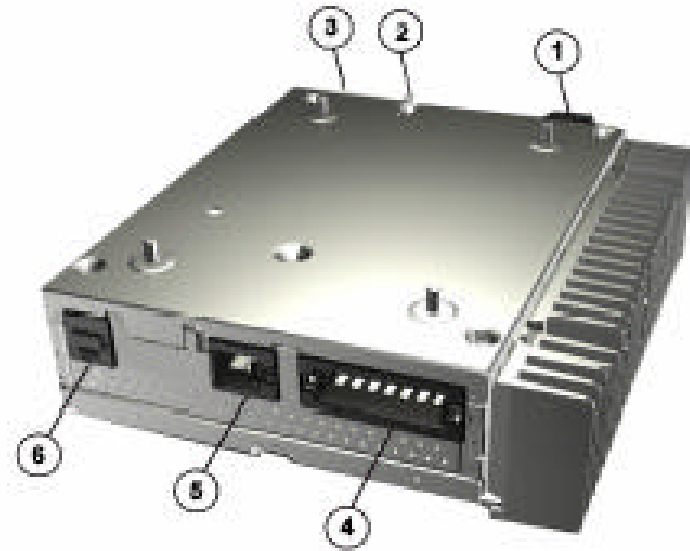

*Located under
passenger foot
rest*

- AGW is included in the optional “Entertainment” package (with COMAND)
- Master of the MOST fiber optic ring and gateway from MOST to CAN B
- harmon/kardon Logic 7 Surround Sound System with output directly to speakers
- Dynamic Range optimization (DRO) microphone input
- Hard-wired radio mute signal received from Tele Aid

harmon/kardon Logic 7

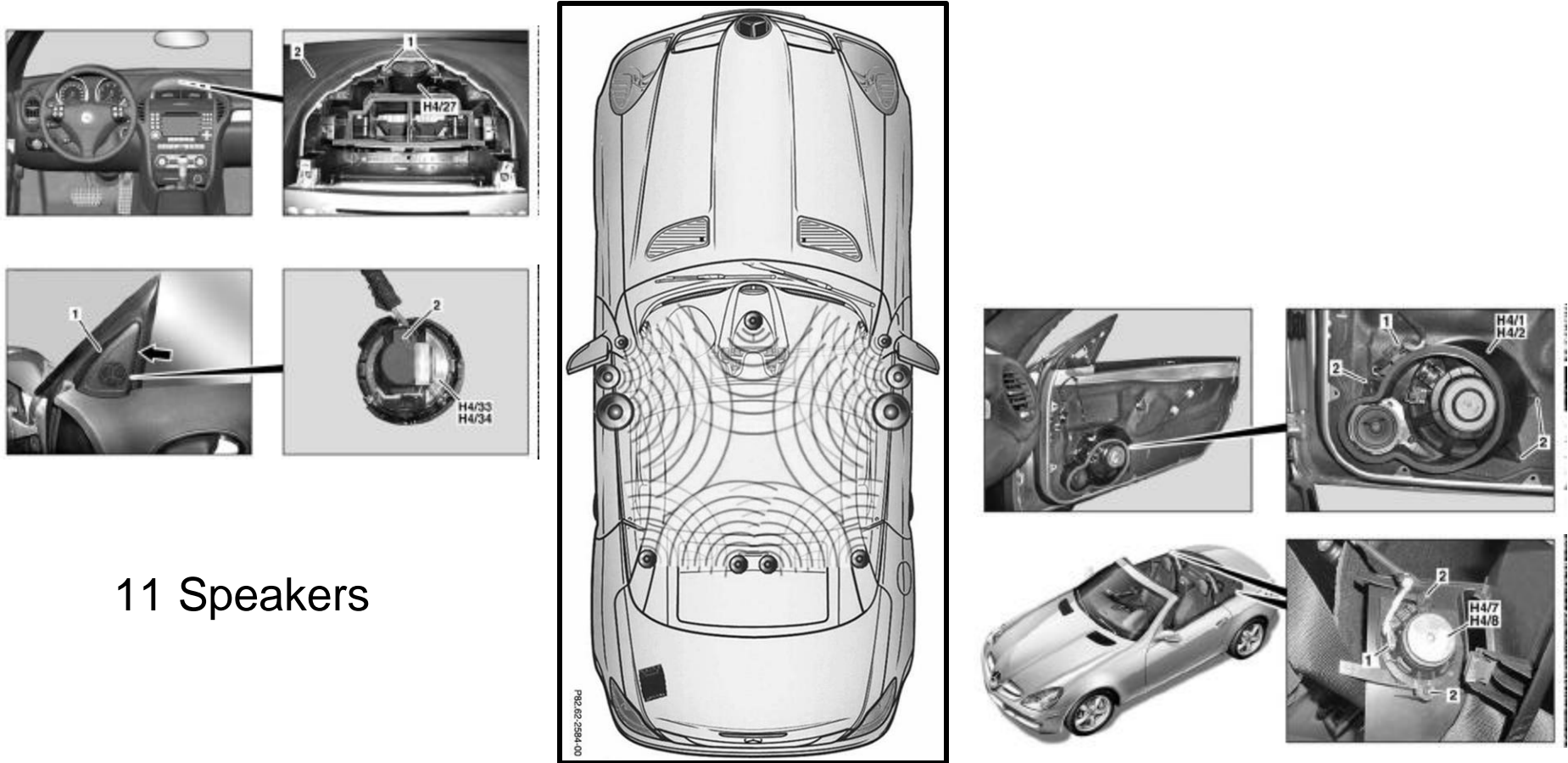

11 Speakers



These 2 speakers are only included with the “Entertainment Package”

Access to the Audio Gateway

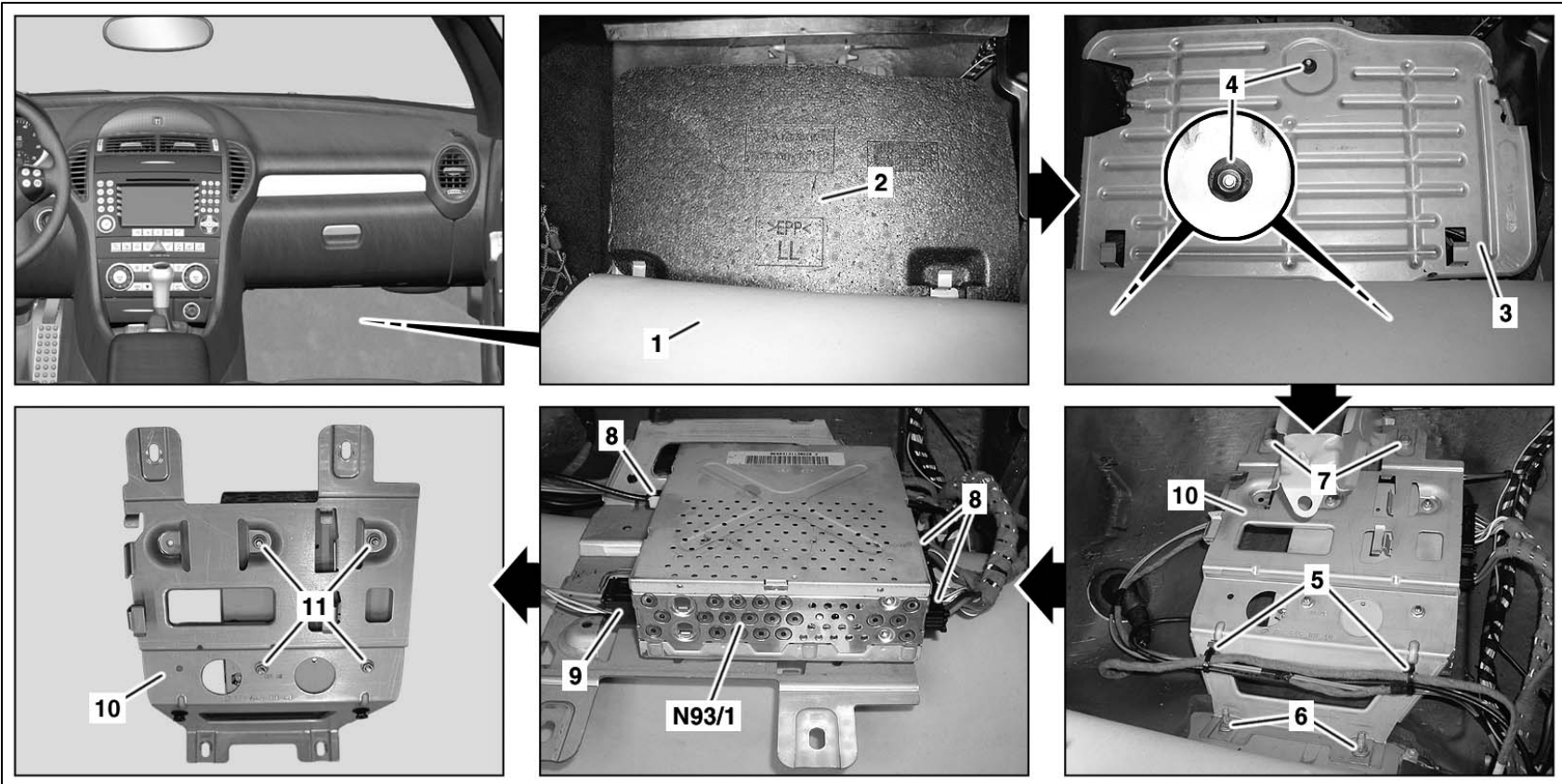

1 Floor mat
 2 Impact damper
 3 Step plate

4 Nuts (3)
 5 Tie strap
 6 Nuts
 7 Bolts

8 Electrical connectors
 9 Fiber optic cable connection
 10 Equipment carrier
 11 Nuts

CD Changer (A2/6)

- Optional with Audio 20
- Standard with “Entertainment” package
- Will not play MP3 discs
- Similar to unit for W211
 - Single-slot 6-disc CD changer (A2/6) fitted in the glove box
 - Automatic CD pull-in
 - Operated via the Head Unit

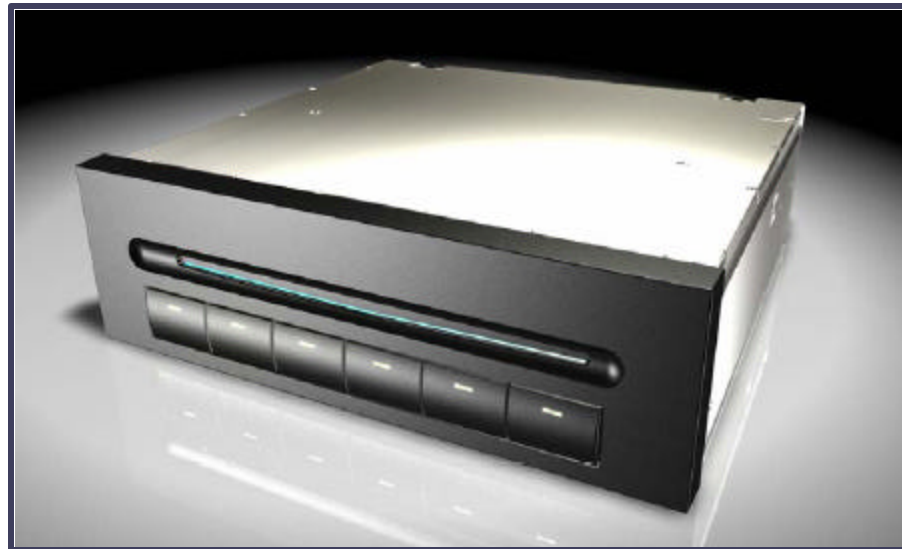

N10/2f19 supplies power

Optional Satellite Radio (N87/5)

- Digital Audio Broadcasting receiver (service provider: Sirius)
- Antenna (A2/82) mounted on trunk lid
 - Receives signals from satellite or terrestrial repeater
- Controlled through Head Unit buttons
- Category/Channel list updated via signal from Sirius
- Update currently takes about 2 minutes
 - Update may change/erase presets

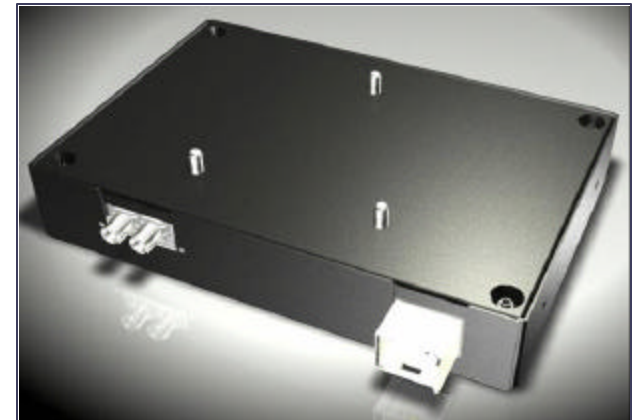
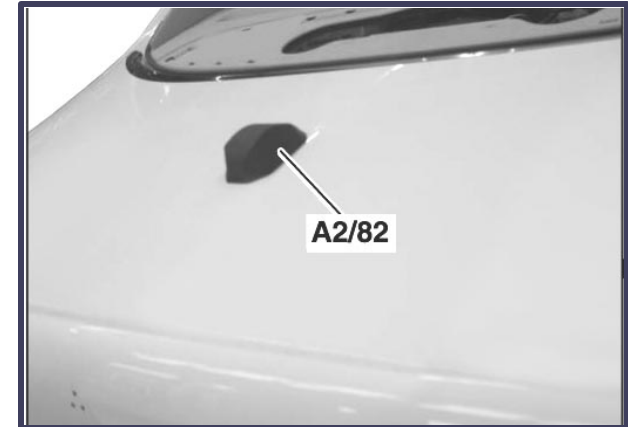

Location: Trunk, left side

Optional Cell Phone

- Phone functions divided into 2 controllers
 - Multiple Handset Interface (MHI) (N123/1) in trunk
 - Cradle in console without coiled cord (private mode not available)
- MHI is in the MOST ring
- Not flashable
- Diagnostics over CAN D / MOST
- Phone Support from MB Motorola only



V60i/x (CDMA/TDMA)



V600 (GSM)*



V710 (CDMA)*

* *With digital camera feature. Expected last half of 2004.*

Cell Phone Components

Multiple Handset Interface

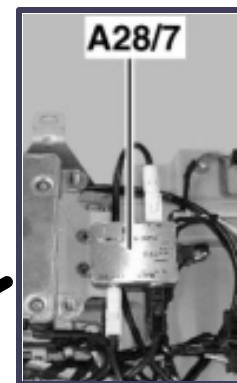

Antenna mast

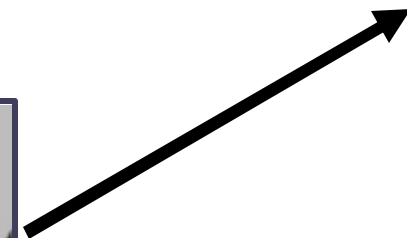

RF Switch



Linear Compensator

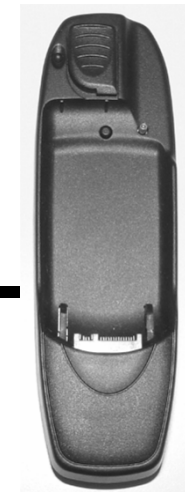

Handset Cradle

All except cradle are mounted on Module Bridge

Handset Cradle

- Provides the physical connection to the mounting plate
- Unique cradle for each type of handset
- Contains the necessary software to translate Motorola cell phone language into a standard language that the Multiple Handset Interface (MHI) understands
- Incorporates software to enhance voice sound quality
- Can be replaced to match future MB phones allowing flexible, easier, more cost effective upgrades without having to replace other phone components

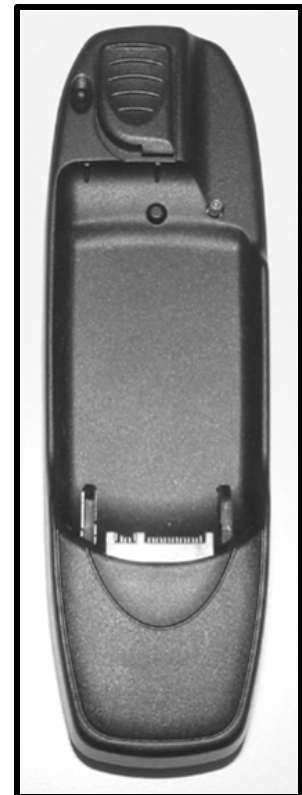

Cell Phone Microphone Connection

Hook-up in trunk— with Cell Phone

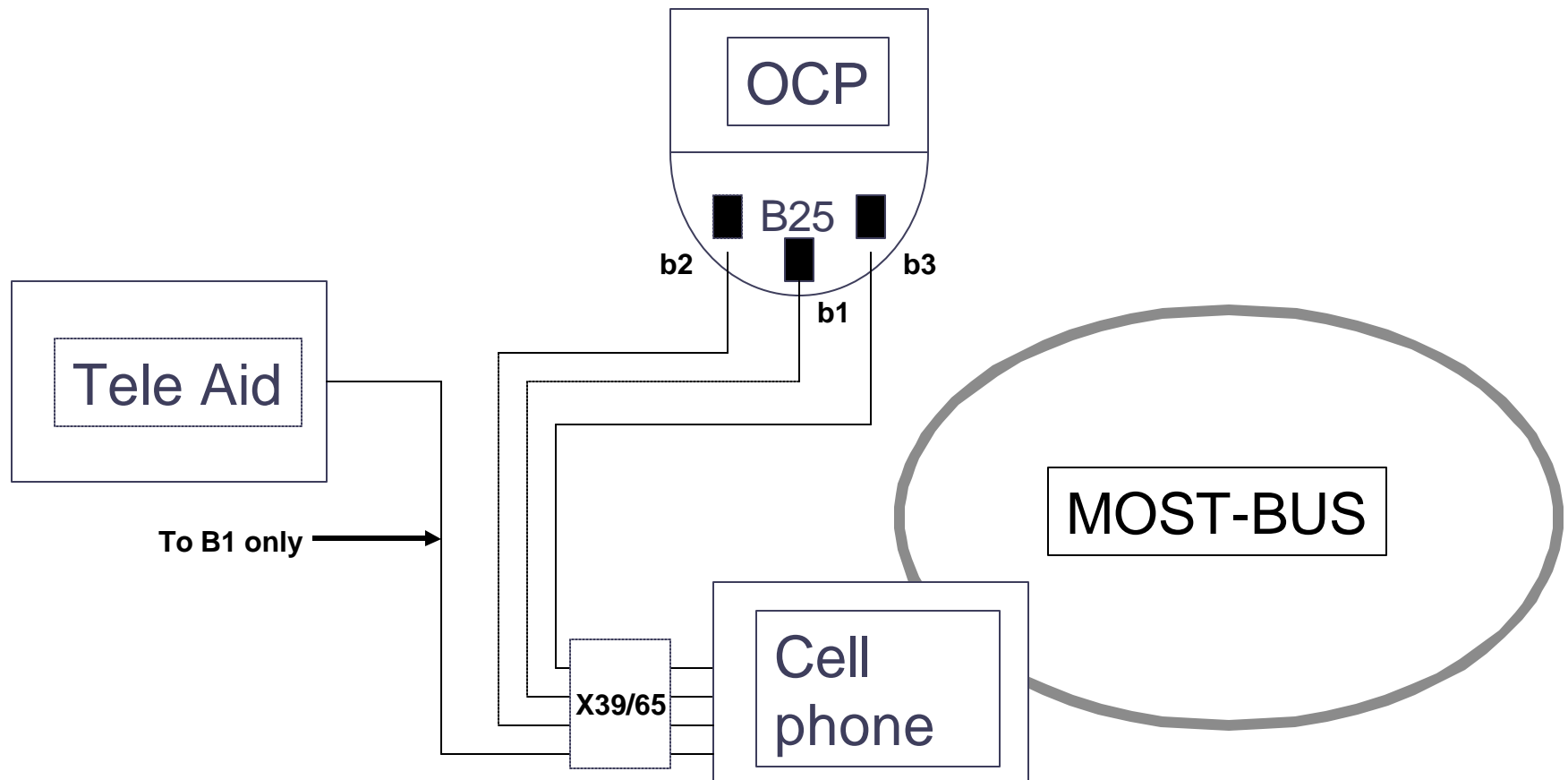

Connecting Microphone for Cell Phone

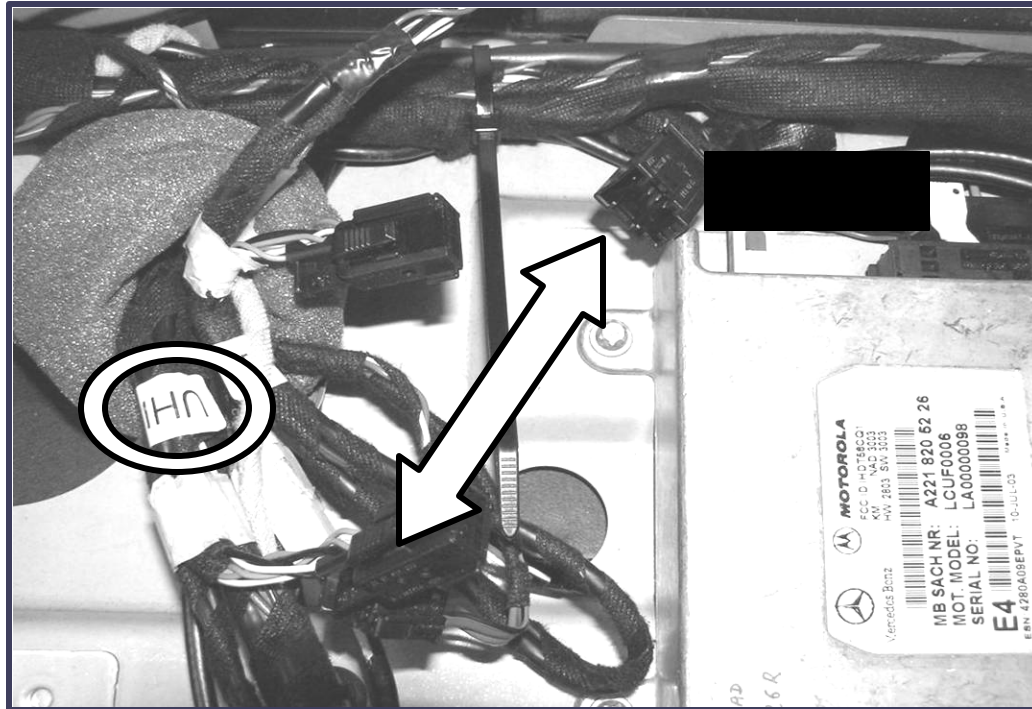

Remove jumper at X39/65 and connect phone (UHI)* connector instead

* UHI is the German acronym for Multiple Handset Interface (MHI)

Review #2

1. Which Head Unit will play MP3 recordings?
2. Describe the components included in the “Entertainment Package”.
3. Is the COMAND unit the “master” of the MOST ring?
4. What components are installed with the cell phone option?

R171 Antennas

1. Antenna mast (A28)
2. GPS antenna (A2/23)
3. Digital Tele Aid back-up antennae (A2/54 & A2/55)
4. Satellite Radio antenna (A2/82)

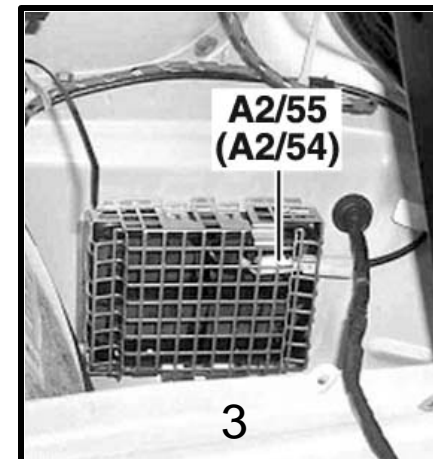
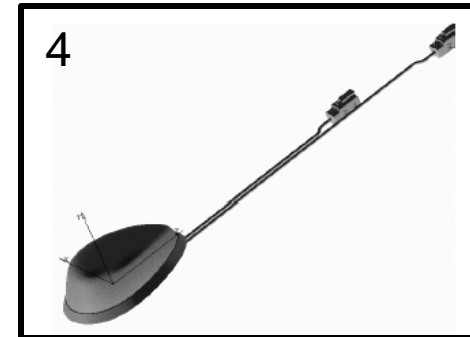
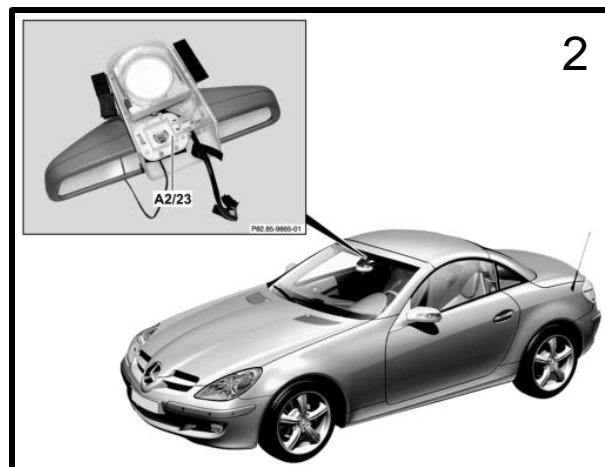
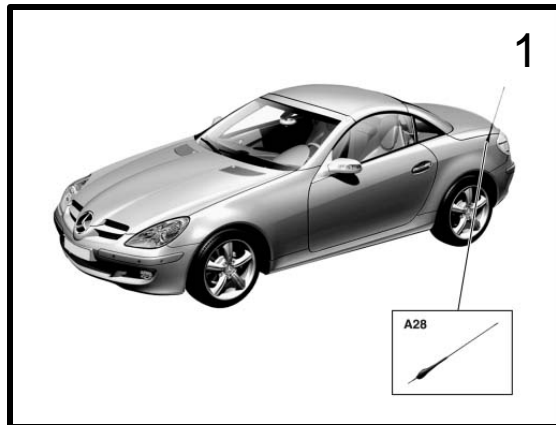

1. Antenna Mast (A28)

- AM / FM
- Central Locking
- Phone (receiving and calling)
 - Digital Tele Aid (main)
 - Cellular phone

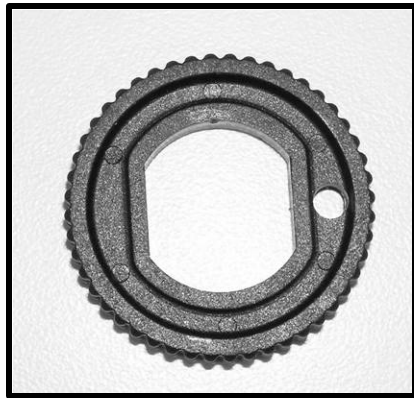

Removal tool included
with vehicle

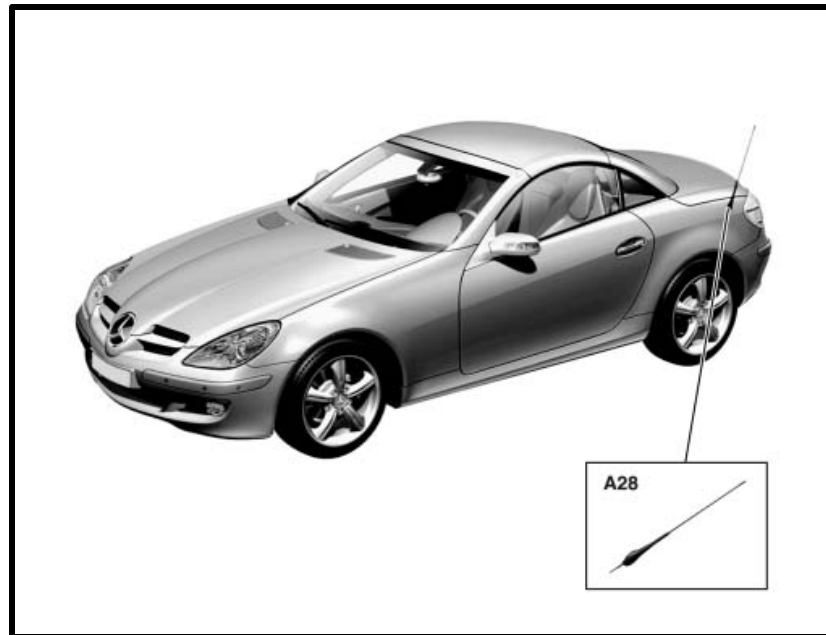

Basic Antenna Mast Signal Path

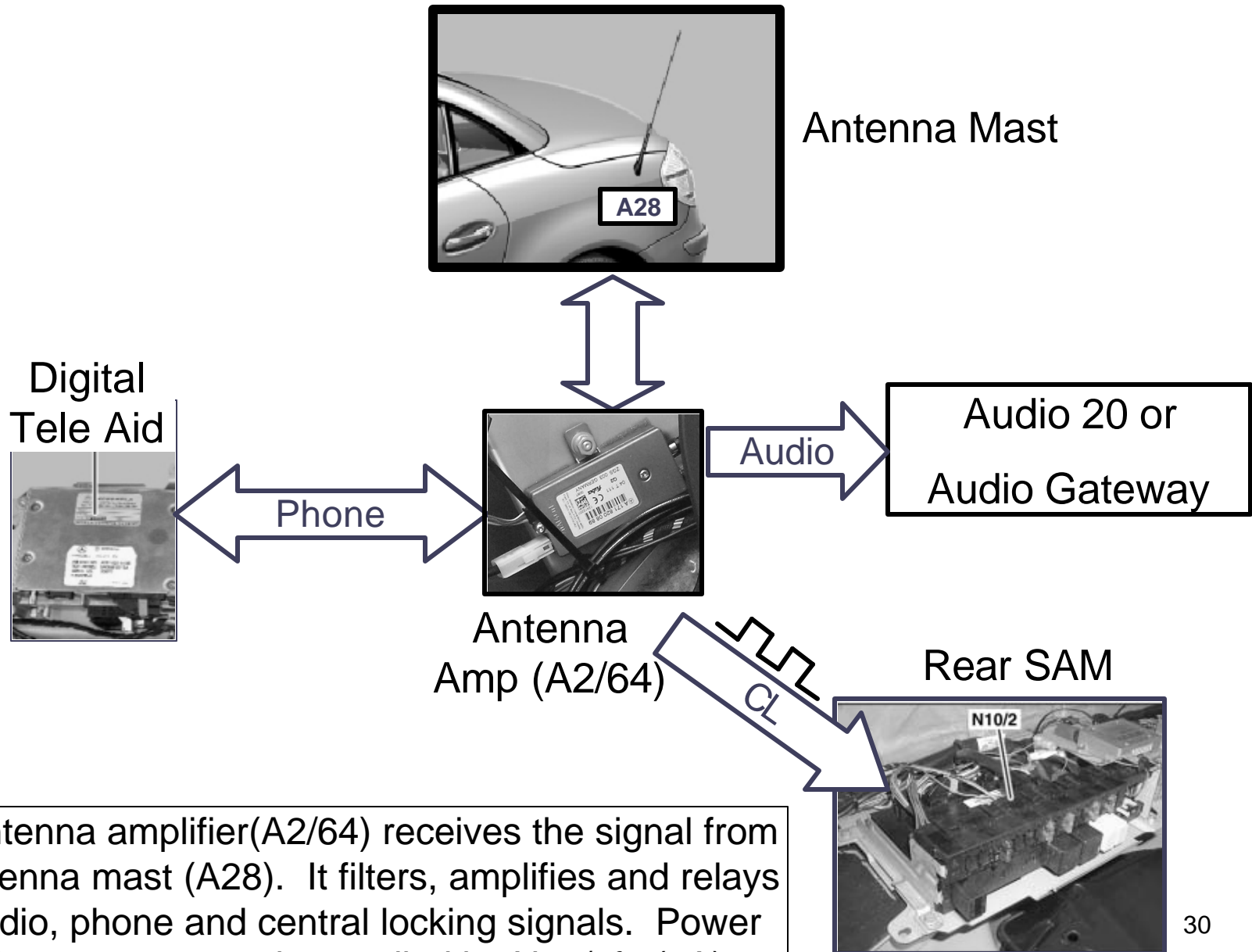

The antenna amplifier(A2/64) receives the signal from the antenna mast (A28). It filters, amplifies and relays the radio, phone and central locking signals. Power for the antenna amp is supplied by N10/2f8 (5A).

2. GPS Antenna (A2/23)

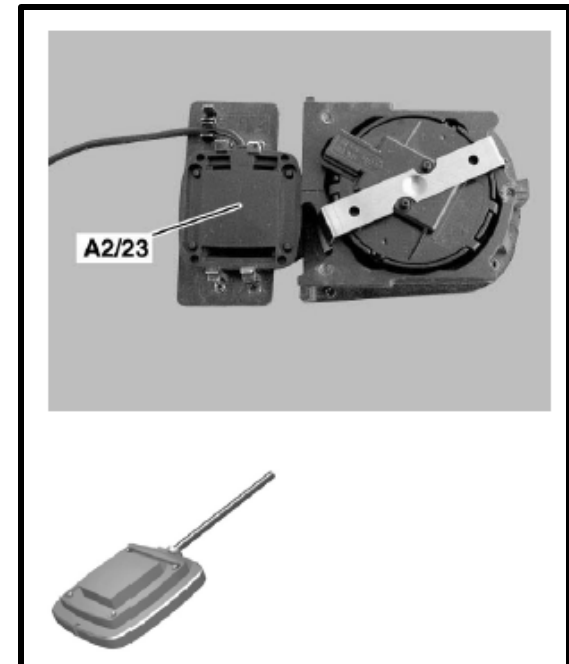
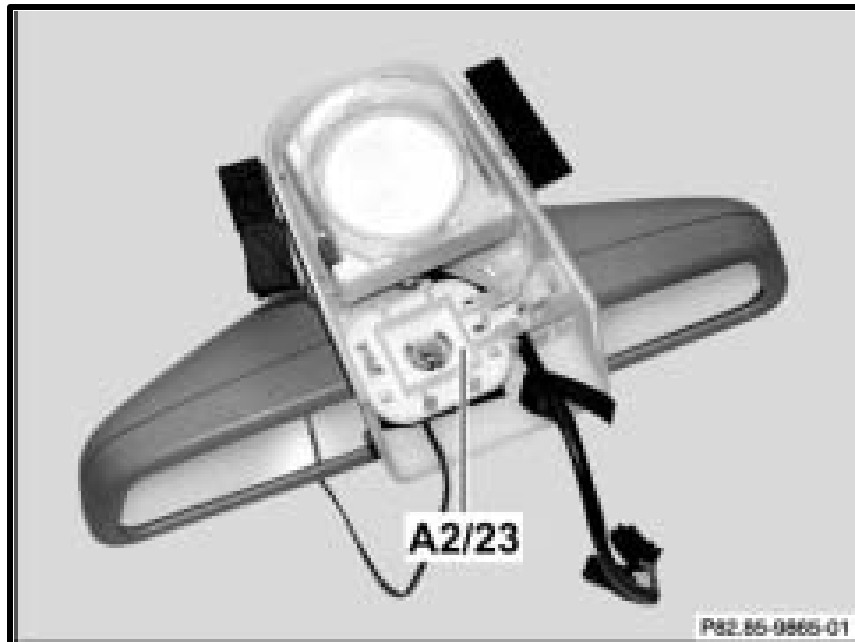

- Mounted above the interior rear view mirror
- Provides position information from the navigation satellites

GPS Antenna Splitter (A2/57)

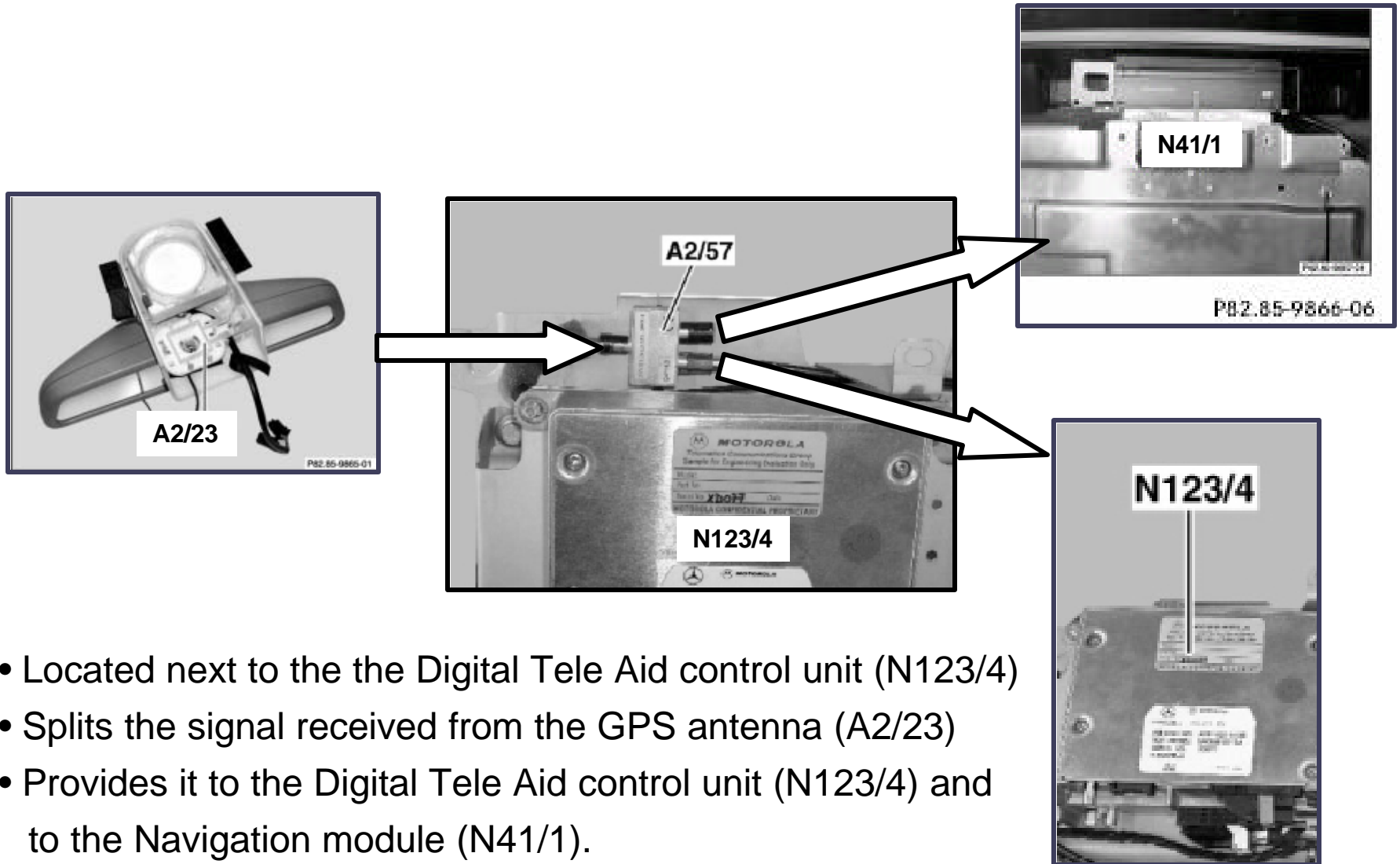

- Located next to the the Digital Tele Aid control unit (N123/4)
- Splits the signal received from the GPS antenna (A2/23)
- Provides it to the Digital Tele Aid control unit (N123/4) and to the Navigation module (N41/1).

3. Digital Tele Aid Back-up Antennae (A2/54 & A2/55)

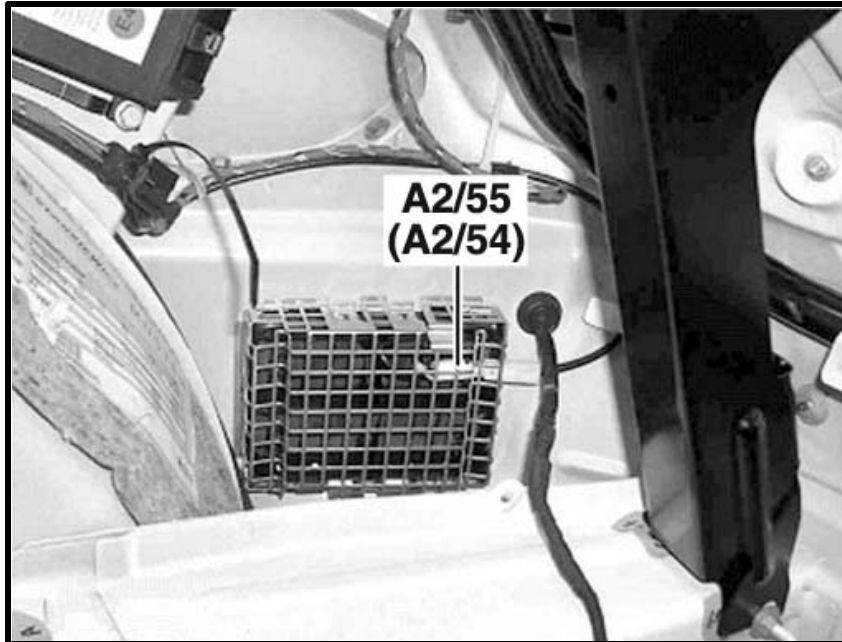

The control unit (N123/4) detects faults or poor reception with the mast antenna and then switches to the back-up antennae.

- Back up antennae (A2/54-left & A2/55-right)
- Installed at both ventilation grates in the left and right corners of the trunk
- If a fault or poor reception characteristics are detected in the antenna mast (A28), these antennae are automatically selected by the Tele Aid control unit (N123/4) .

Backup Antenna Combiner (A2/53)

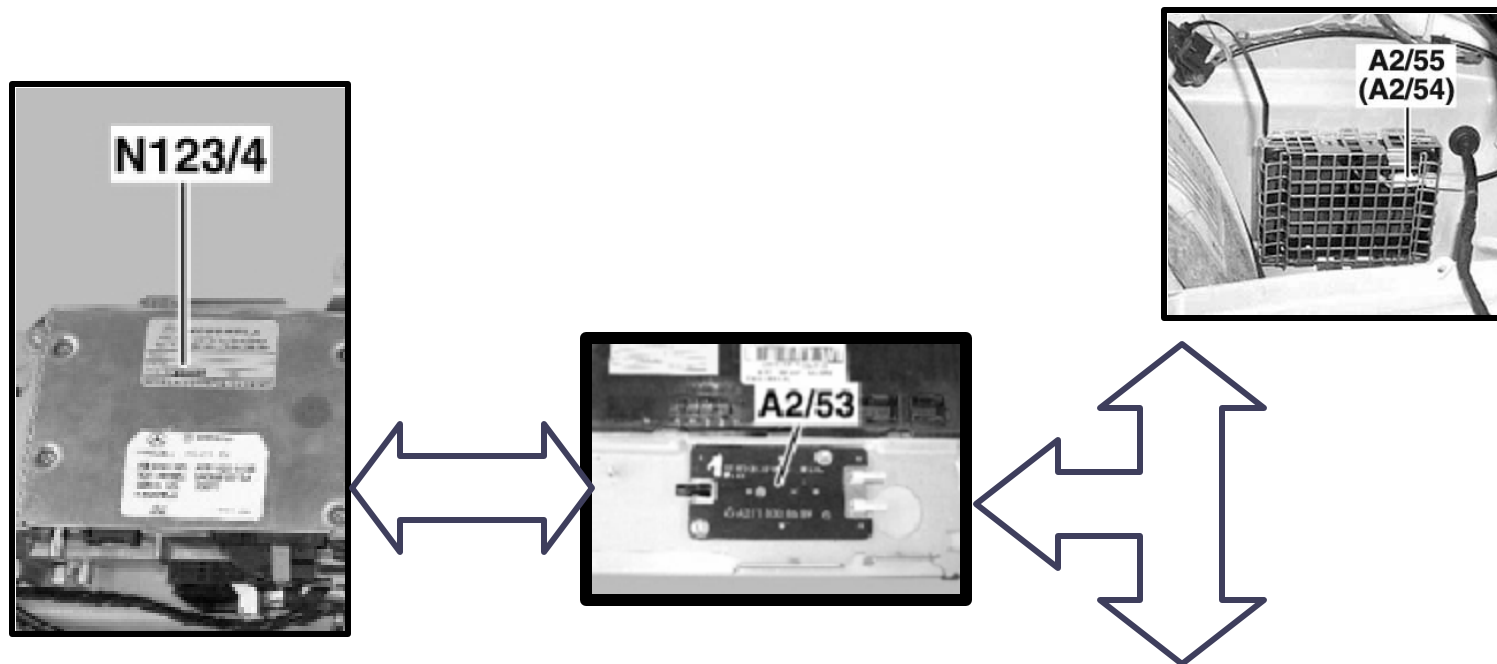

- Receives and combines the signals from both back up antennae (A2/54 & A2/55)
- Combined signal is transmitted to the Tele Aid control unit (N123/4).

4. Satellite Radio Antenna (A2/82)

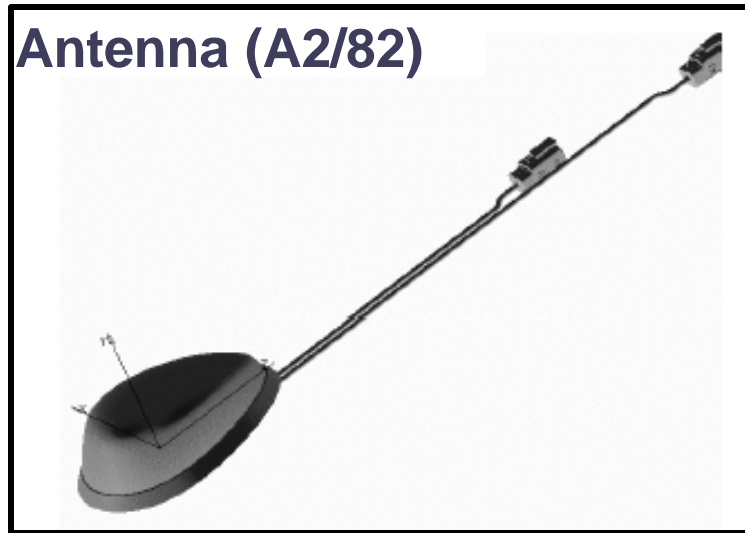

- Mounted on trunk lid
- Two leads:
 1. Satellite signal
 2. Terrestrial repeater

Satellite Radio Signal Path



(Lower left side of trunk)

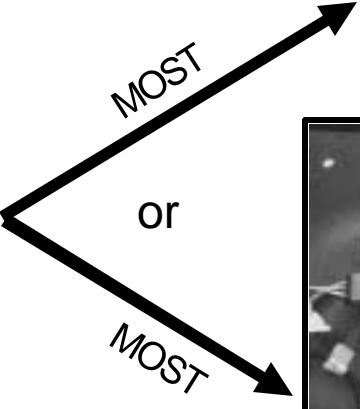

(Beneath passenger footrest)

Audio Gateway

Appendix

Power Supply for audio & communication control units

Connector information for components on MOST ring

- Digital Tele Aid
- Audio 20
- COMAND
- Audio Gateway (AGW)
- Multiple Handset Interface
- CD Changer
- Satellite Radio

Power Supply

- Head Unit
 - N10/1f64 (10A)
- Audio Gateway
 - N10/1f64 (10A), N10/1f47 (15A) → circuit 15R in SAM
- Multiple Handset Interface
 - N10/2f16 (7.5A), N10/2f3 (7.5A)
- Satellite Radio Receiver
 - N10/2f17 (5A)
- CD Changer
 - N10/2f19 (7.5A)
- Navigation
 - N10/2f19 (7.5A)

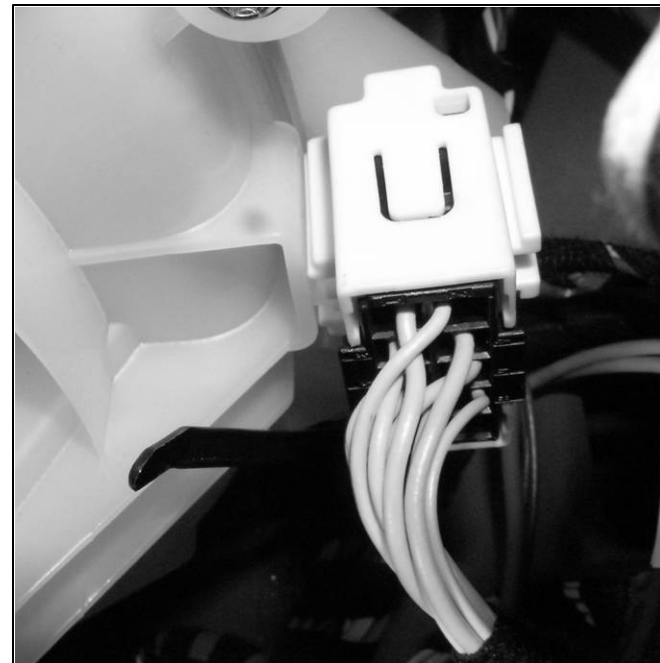

Location: Right side of AC blower housing
X30/8 Wake up signal connector - pink
Tel Mute Line (Tele Aid) - yellow

Digital Tele Aid – Connectors

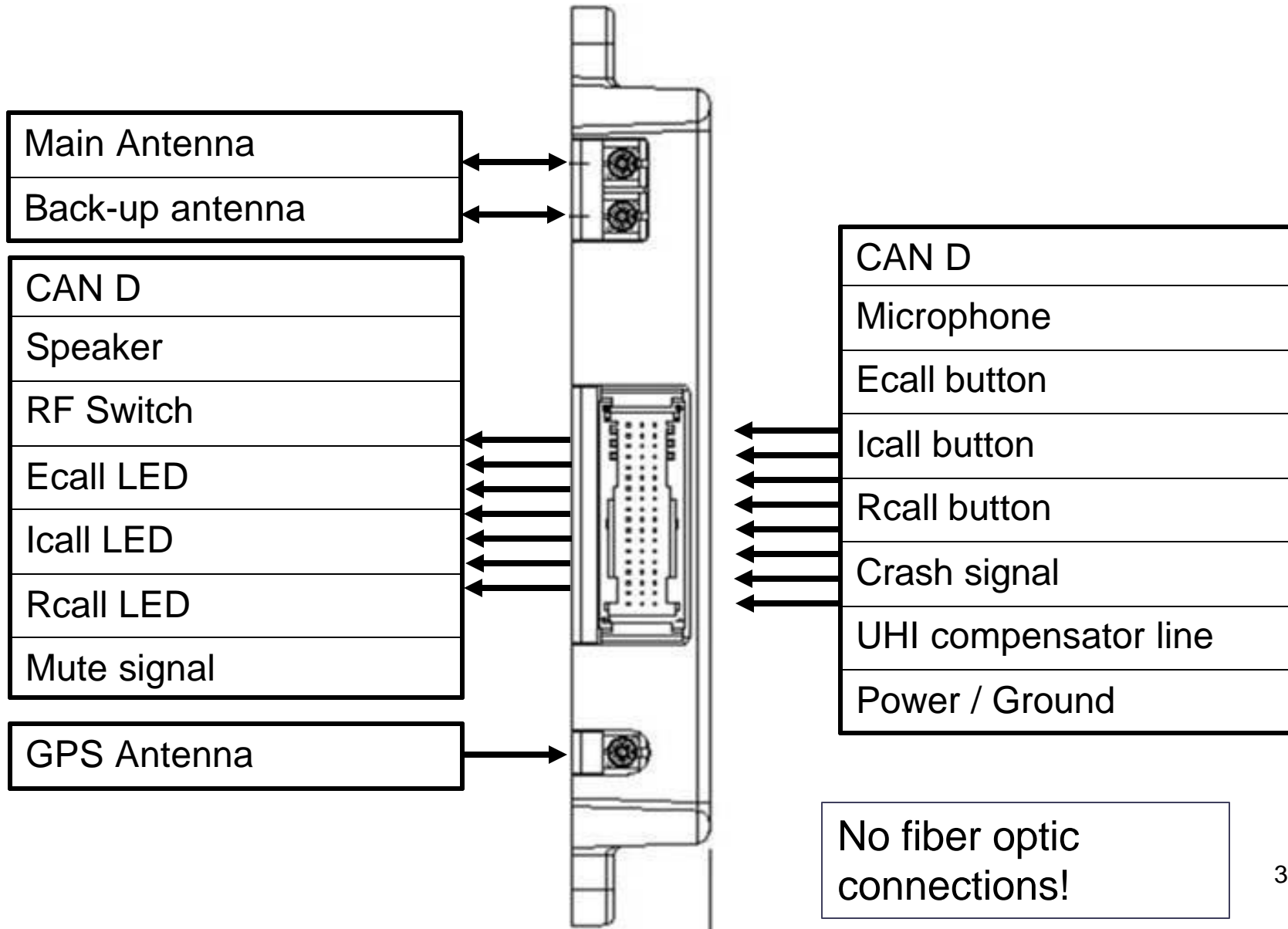

Audio 20 Connectors

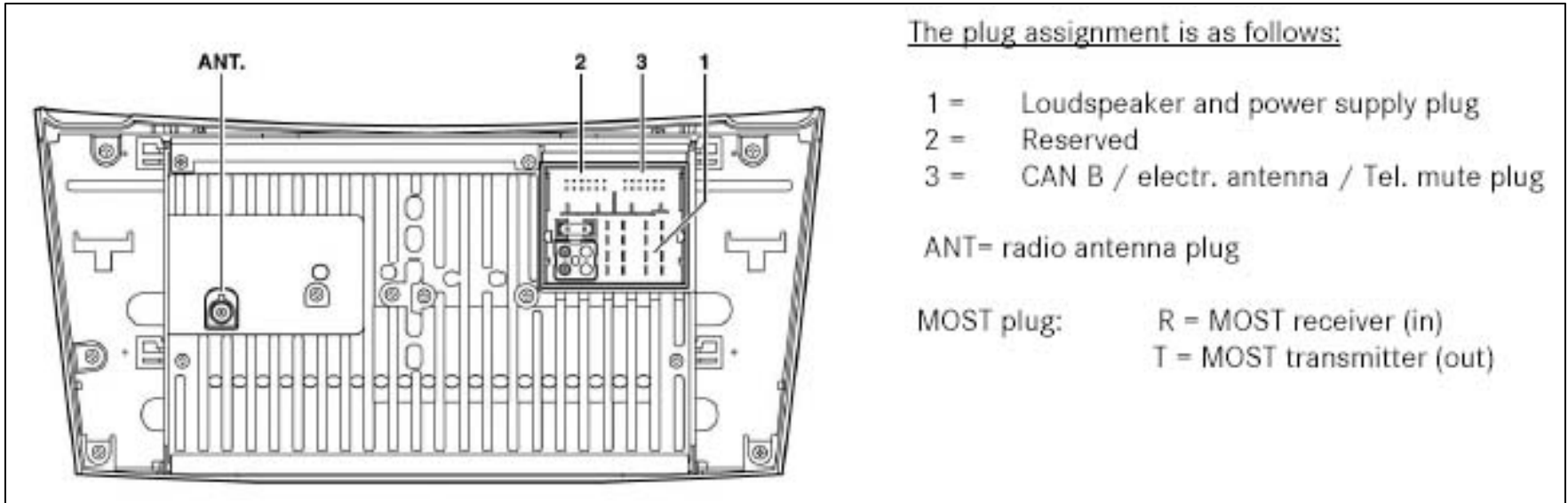

Connector assignment 1 loudspeaker / power supply:		Connector 1	Connector assignment 3 CAN B, el. antenna, tel. mute:		Connector 2
PIN	signal / signal info.		PIN	signal / signal info.	
1	FL +		1	CAN high	
2	FL -		2	CAN low	
3	RL +		3	El. antenna actuation	
4	RL -		4	Wake-up	
5	FR +		5	Telephone mute	
6	FR -		6-12	Reserved	
7	RR +				
8	RR -				
9-14	Reserved				
15	Ubat- (T.31)				
16	Ubat+ (T.30)				

No Auxiliary Jack

COMAND Connectors

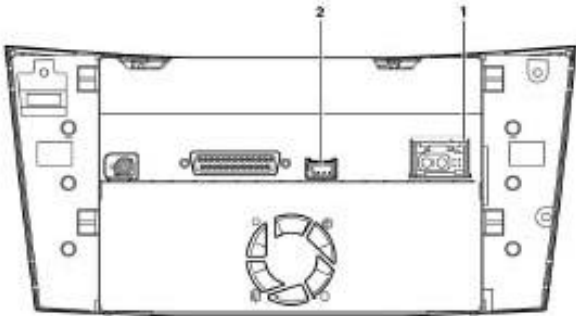

Connectors on the COMAND HU

- 1 MOST/power supply connection plug
- 2 AUX socket, glove compartment

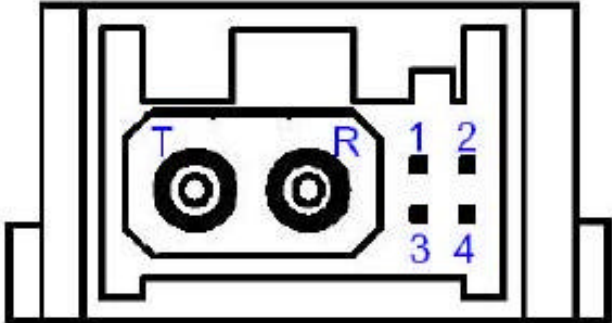

Pin assignment plug 1

PIN	signal / signal info.
T	MOST output (out)
R	MOST input (in)
1	T. 30
2	T. 31
3	Electrical wake-up
4	Reserved

Pin assignment plug 2

PIN	signal/signal info.
1	LF-R
2	shielding
3	LF-L

41

Audio Gateway (N93/1) Connectors

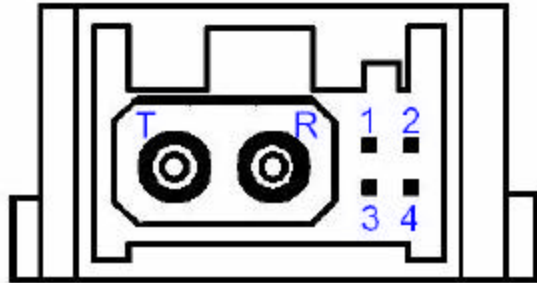

MOST connection plug ①

PIN	signal / signal info.
T	MOST output (out)
R	MOST input (in)
1	Telephone mute
2	CAN B high
3	Electrical wake-up
4	CAN B low

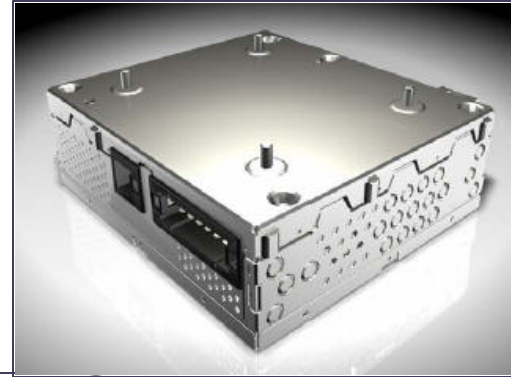

Loudspeaker connections connection plug ④

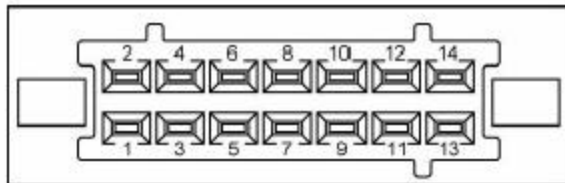

PIN	signal/ signal info.	PIN	signal/ signal info.
1	SUB1+ (TT l)	8	FL- (MHT l)
2	SUB1- (TT l)	9	RL+ (rear fill l)
3	SUB2+ (TT r)	10	RL- (rear fill l)
4	SUB2- (TT r)	11	RR+ (rear fill r)
5	CENTER+ (center fill)	12	RR- (rear fill r)
6	CENTER- (center fill)	13	FR+ (MHT r)
7	FL+ (MHT l)	14	FR- (MHT r)

TT= woofer

MHT= middle/tweeter

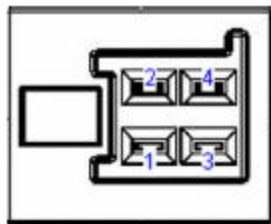

Connection plug power supply /+antenna ⑤

PIN	signal / signal info.
1	Antenna control output
2	Reserved
3	Supply voltage (T. 31)
4	Supply voltage (T. 30)

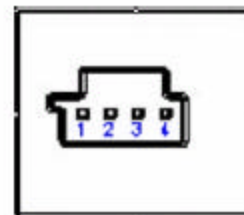

DRO microphone connection plug ⑥

PIN	signal / signal info.
1	Reserved
2	Microphone shielding
3	Microphone-
4	Microphone+

Multiple Handset Interface (N123/1) Connectors

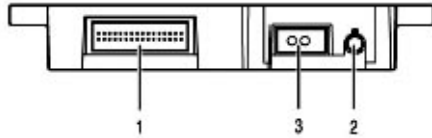

The plug assignment is as follows:

- 1 = Power supply/cradle connection /microphone connection plug
- 2 = Bluetooth antenna plug
- 3 = MOST

Connector assignment ① power supply/cradle connection /microphone connection plug

PIN	signal / signal info.	PIN	signal / signal info.
1	DEBUG TXD	17	VC (cradle)
2	DEBUG RXD	18	Ground (cradle)
3	T. 31	19	Reserved
4	T. 31	20	T. 30
5	Res.	21	T. 30
6	Shielding	22	TX - (cradle)
7	Res.	23	TX + (cradle)
8	Res.	24	Ext. wake-up
9	Res.	25	RX + (cradle)
10	TeleAid microphone GND (with LCT)	26	RX - (cradle)
11	Microphone Array shielding (microphone group)	27	LS - (cradle)
12	Microphone ground (GND) (microphone group)	28	Compensator
13	TeleAid microphone OUT (with LCT)	29	Microphone 1 (microphone group)
14	LS+ (cradle)	30	Microphone 2 (microphone group)
15	Microphone + (cradle)	31	Microphone 3 (microphone group)
16	Microphone - (cradle)	32	Microphone 4 (microphone group) not with R171



Connector assignment ③ MOST plug

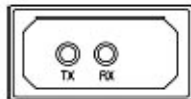

- PIN signal / signal info.
- TX MOST output (out)
- RX MOST input (in)

Satellite Radio(N87/5) Connectors

4 - Pole connector with MOST

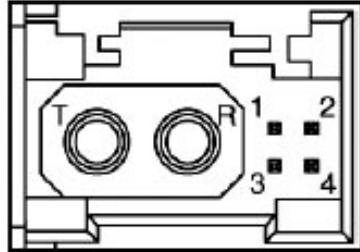

PIN	Signal/Signalinfo
T	MOST Tx (output)
R	MOST Rx (input)
1	T. 31
2	T. 30
3	Wake up
4	Not used



Satellite Antenna
Terrestrial: Neutral color



PIN	Signal
X	S Band-Terrestrial Input
S	Shielded ground

Satellite Antenna: Blue color



PIN	Signal
X	S Band-Satellite Input
S	Shielded ground